

Hilluvinklar, Festingar PN

Hilluvinkill heitgalv. styrkt



Art. nr.	Pakning	Overflade	A mm	B mm	Dim.	Skrue bolt	Bæreevne kg	Stk. pr. pk.
600100107	KP	varmforzinket	200	250	30x30x4	5	250	1
600100437	KP	hvid pulverlak	200	250	30x30x4	5	250	1
600200107	KP	varmforzinket	250	300	30x30x4	5	250	1
600200437	KP	hvid pulverlak	250	300	30x30x4	5	250	1

Hilluvinkill hvítur



Art. nr.	Pakning	Overflade	A mm	B mm	Dim.	Skrue bolt	Stk. pr. pk.
600300237	KP	hvid	175	225	1	3,5	20
600500237	KP	hvid	75	100	1	3	20
600600237	KP	hvid	100	125	1	3	20
600700237	KP	hvid	125	150	1	3	20
600800237	KP	hvid	150	200	1	3,5	20
600900237	KP	hvid	200	250	1	3,5	20
601000237	KP	hvid	250	300	1	3,5	20
601100237	KP	hvid	300	350	1,5	3,5	20
605100237	KP	hvid	350	400	1,5	3,5	10

Hillu-/Borðvinklar hvítir "U" laga

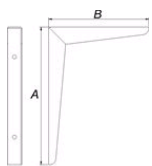

Art. nr.	Pakning	Overflade	A mm	B mm	Dim.	Skrue bolt	Bæreevne kg	Stk. pr. pk.
600400437	KP	hvid pulverlak	300	220	2,5	5/8	200	1
601200437	KP	hvid pulverlak	300	300	2,5	5/8	175	1
601300437	KP	hvid pulverlak	300	400	2,5	5/8	125	1
601400437	KP	hvid pulverlak	300	550	2,5	5/8	100	1

Hillu-/Borðvinklar hvítir “L” laga

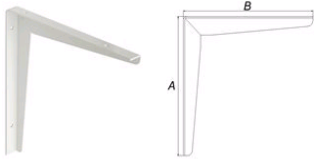

Art. nr.	Pakning	Overflade	A mm	B mm	Dim.	Skrue bolt	Bæreevne kg	Sæt pr. pk.
601500439	KP	hvid pulverlak	300	300	3	5/6	120	1
601600439	KP	hvid pulverlak	300	400	3	5/6	90	1
601700439	KP	hvid pulverlak	300	550	3	5/6	65	1

Hillu-/Borðvinkill

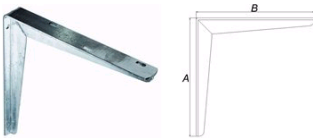

Art. nr.	Pakning	Overflade	A mm	B mm	Dim.	Skrue bolt	Bæreevne kg	Stk. pr. pk.
602100107	KP	varmforzinket	300	300	40x40x5	5/8	250	1
602100437	KP	hvid pulverlak	300	300	40x40x5	5/8	250	1
602200107	KP	varmforzinket	300	400	40x40x5	5/8	250	1
602200437	KP	hvid pulverlak	300	400	40x40x5	5/8	250	1
602300107	KP	varmforzinket	300	550	40x40x5	5/8	250	1
602300437	KP	hvid pulverlak	300	550	40x40x5	5/8	250	1

Rörberi Hvítur minni

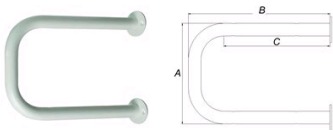

Art. nr.	Pakning	Overflade	A mm	B mm	C mm	Dim.	Skrue bolt	Stk. pr. pk.
602400437	KP	hvid pulverlak	175	250	185	22x1,5	4,5	1
602500437	KP	hvid pulverlak	305	250	185	22x1,5	4,5	1
602600437	KP	hvid pulverlak	305	350	285	22x1,5	4,5	1

Skrúfur m. skífu f. 22mm 4 í setti



Art. nr.	Pakning	Overflade	A mm	Skrue bolt	Sæt pr. enh.	Sæt pr. pk.
603009031	SB	hvid	14	4,5x40	4	10

Borðvinkill m/hillu

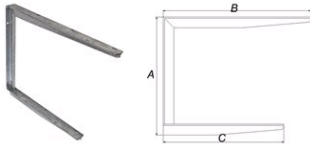

Art. nr.	Pakning	Overflade	A mm	B mm	C mm	Dim.	Skrue bolt
603300107	KP	varmforzinket	440	550	450	40x40x5	5/8
603300437	KP	hvid pulverlak	440	550	450	40x40x5	5/8

Skrúfur m.skífu f. 32mm

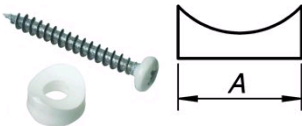

Art. nr.	Pakning	Overflade	A mm	Skrue bolt	Stk. pr. pk.
603409030	LP	hvid	22	50x5	50
603409031	SB	hvid	22	50x5	10

Rörberi Hillu stærri

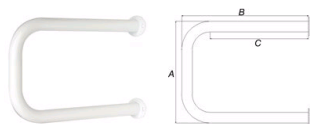

Art. nr.	Pakning	Overflade	A mm	B mm	C mm	Dim.	Skrue bolt	Stk. pr. pk.
603500437	KP	hvid pulverlak	255	385	300	32x1,5	5,5	1
603600437	KP	hvid pulverlak	305	385	300	32x1,5	5,5	1
603700437	KP	hvid pulverlak	405	385	300	32x1,5	5,5	1

Rörberi, slá hvít

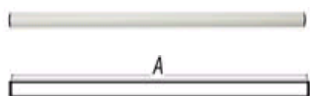

Art. nr.	Pakning	Overflade	A mm	B mm	Dim.	Skrue bolt	Stk. pr. pk.
603800437	KP	hvid pulverlak	800	25	1,5	5,5	1
603900437	KP	hvid pulverlak	1200	25	1,5	5,5	1

Rörberi, hilla/bekk stærri

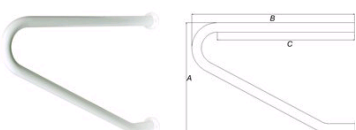

Art. nr.	Pakning	Overflade	A mm	B mm	C mm	Dim.	Skrue bolt	Stk. pr. pk.
604100437	KP	hvid pulverlak	370	550	465	32x1,5	8	1

Rörberi, hilla/borð

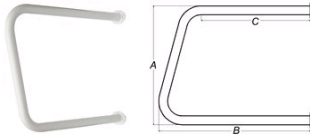

Art. nr.	Pakning	Overflade	A mm	B mm	C mm	Skrue bolt	Dim.	Stk. pr. pk.
604200437	KP	hvid pulverlak	430	550	400	8	32x1,5	1

Rörberi f.hillu

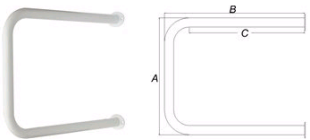

Art. nr.	Pakning	Overflade	A mm	B mm	C mm	Dim.	Skrue bolt	Stk. pr. pk.
604300437	KP	hvid pulverlak	405	485	400	32x1,5	8	1

Hilluvinklar

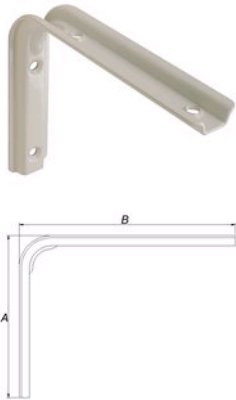

Art. nr.	Pakning	Overflade	A mm	B mm	Dim.	Skrue bolt	Stk. pr. pk.
604500307	KP	elforzinket	125	150	2	5	10
604500417	KP	grå pulverlak	125	150	2	5	10
604500437	KP	hvid pulverlak	125	150	2	5	10
604600307	KP	elforzinket	150	200	2	5	10
604600417	KP	grå pulverlak	150	200	2	5	10
604600437	KP	hvid pulverlak	150	200	2	5	10
604700307	KP	elforzinket	200	250	2	5	10
604700417	KP	grå pulverlak	200	250	2	5	10
604700437	KP	hvid pulverlak	200	250	2	5	10

Skrúfur m/tappa hvítar



Art. nr.	Pakning	Overflade	Skrue bolt	Stk. pr. pk.
604900530	LP	hvid pulverlak	5,5x50	100
604900531	SB	hvid pulverlak	5,5x50	10

Sólbekkjajárn

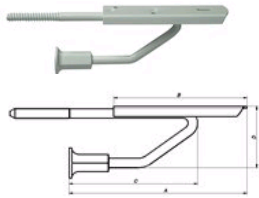

Art. nr.	Pakning	Overflade	A mm	B mm	C mm	Dim.	Skrue bolt	Stk. pr. pk.
606000430	LP	pulverlak. hvid	180	130	140	2	6	1
606100430	LP	pulverlak. hvid	220	175	130	2	6	1

Hilluvinkill

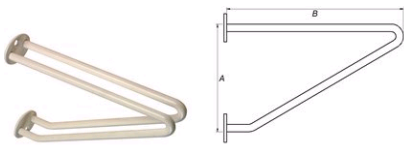

Art. nr.	Pakning	Overflade	A mm	B mm	Dim.	Skrue bolt	Stk. pr. pk.
606500437	KP	hvid pulverlak	115	190	8	4,5	1
606500707	KP	forkromet	115	190	8	4,5	1
606600437	KP	hvid pulverlak	172	290	8	4,5	1
606600707	KP	forkromet	172	290	8	4,5	1

Hilluvinkill Profil

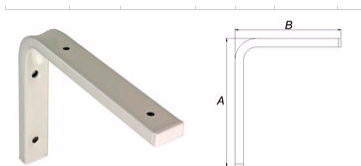

Art. nr.	Pakning	Overflade	A mm	B mm	Dim.	Skrue bolt	Stk. pr. pk.
608000417	KP	grå pulverlak	150	125	22x10x1,5	5,5/4,5	10
608000437	KP	hvid pulverlak	150	125	22x10x1,5	5,5/4,5	10
608100417	KP	grå pulverlak	200	150	22x10x1,5	5,5/4,5	10
608100437	KP	hvid pulverlak	200	150	22x10x1,5	5,5/4,5	10
608200417	KP	grå pulverlak	250	200	22x10x1,5	5,5/4,5	10
608200437	KP	hvid pulverlak	250	200	22x10x1,5	5,5/4,5	10

Hilluvinkill m/skástífu



Art. nr.	Pakning	Overflade	A mm	B mm	Dim.	Skrue bolt	Stk. pr. pk.
608500437	KP	hvid pulverlak	180	290	30x4	5/6	1
608600437	KP	hvid pulverlak	250	390	30x4	5/6	1
608700437	KP	hvid pulverlak	320	490	30x4	5/6	1

Hlið-loka læsanleg 2stk.

Art. nr.	Pakning	Overflade	A mm	B mm	C mm	Dim.	Skrue bolt	Stk. Pr. Enh.
609500101	SB	varmforzinket	165	60	70	5	5,5	2

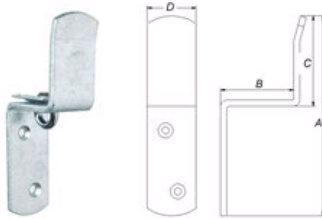

Vinkiljárn

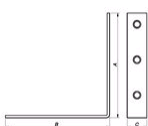
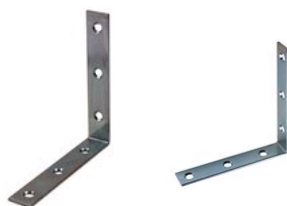
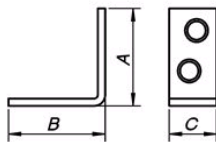
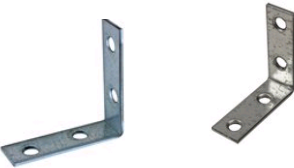
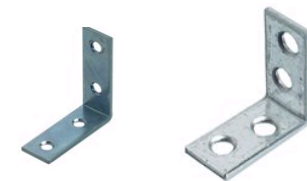

Art. nr.	Pakning	Overflade	A mm	B mm	C mm	Dim.	Skrue bolt	Stk. pr. pk.
610000300	LP	elforzinket	26	26	13	2	3	50
610000301	SB	elforzinket	26	26	13	2	3	10
610000307	KP	elforzinket	26	26	13	2	3	50
610008907	KP	rustfri	26	26	13	2	3	25
610100300	LP	elforzinket	39	39	13	2	3	50
610100301	SB	elforzinket	39	39	13	2	3	10
610100307	KP	elforzinket	39	39	13	2	3	50
611000300	LP	elforzinket	52	52	15	2	3,5	50
611000307	KP	elforzinket	52	52	15	2	3,5	50
611100300	LP	elforzinket	55	55	20	2,5	3,5	50
611100301	SB	elforzinket	55	55	20	2,5	3,5	10
611100307	KP	elforzinket	55	55	20	2,5	3,5	50
611108907	KP	rustfri	55	55	20	2,5	3,5	25
611200300	LP	elforzinket	67	67	20	2,5	3,5	50
611200301	SB	elforzinket	67	67	20	2,5	3,5	10
611200307	KP	elforzinket	67	67	20	2,5	3,5	50
611208907	KP	rustfri	67	67	20	2,5	3,5	25
611300300	LP	elforzinket	80	80	20	2,5	3,5	25
611300301	SB	elforzinket	80	80	20	2,5	3,5	10
611300307	KP	elforzinket	80	80	20	2,5	3,5	25
611500300	LP	elforzinket	107	107	20	2,5	3,5	25
611500301	SB	elforzinket	107	107	20	2,5	3,5	5
611600300	LP	elforzinket	133	133	25	3	5	25
611600307	KP	elforzinket	133	133	25	3	5	25
611800307	KP	elforzinket	135	135	25	5	5	1
611900307	KP	elforzinket	158	158	25	5	4,5	1

Vinkiljárn breið

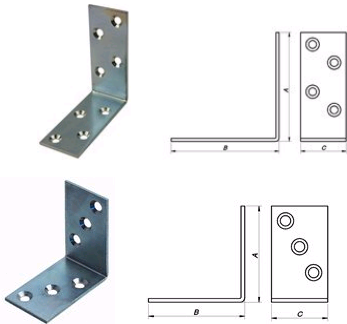

Art. nr.	Pakning	Overflade	A mm	B mm	C mm	Dim.	Skrue bolt	Stk. pr. pk.
613000307	KP	elforzinket	45	45	38	2,5	5	25
613100307	KP	elforzinket	65	65	38	2,5	5	25
613200307	KP	elforzinket	90	90	38	2,5	5	25

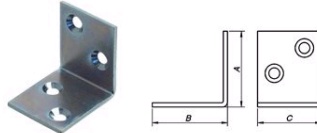

Vinkiljárn breið

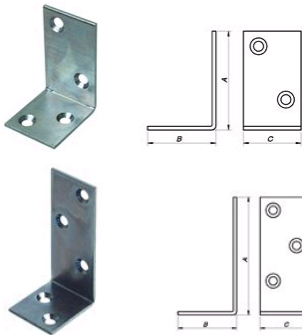

Art. nr.	Pakning	Overflade	A mm	B mm	C mm	Dim.	Skrue bolt	Stk. pr. pk.
614000307	KP	elforzinket	65	45	38	2,5	5	25
614100307	KP	elforzinket	90	45	38	2,5	5	25
614200307	KP	elforzinket	115	65	38	2,5	5	25

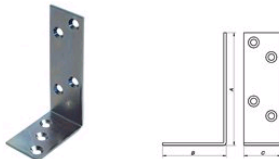

Vinkiljárn breið

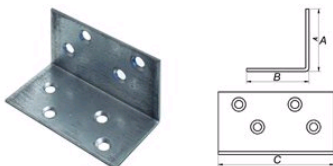

Art. nr.	Pakning	Overflade	A mm	B mm	C mm	Dim.	Skrue bolt	Stk. pr. pk.
615000307	KP	elforzinket	50	50	93	2,5	5	25

Vinkiljárn heitgalv.

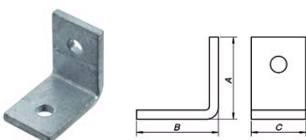

Art. nr.	Pakning	Overflade	A mm	B mm	C mm	Dim.	Skrue bolt	Stk. pr. pk.
617000107	KP	varmforzinket	45	45	30	5	9	25
617100107	KP	varmforzinket	95	95	30	5	9	25
617200107	KP	varmforzinket	145	145	30	5	9	25

Flatjárn

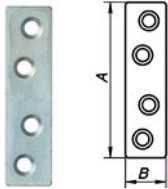

Art. nr.	Pakning	Overflade	A mm	B mm	Dim.	Skrue bolt	Stk. pr. pk.
620100301	SB	elforzinket	50	13	2	3	10
620100307	KP	elforzinket	50	13	2	3	50

Flatjárn

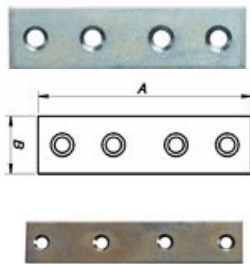

Art. nr.	Pakning	Overflade	A mm	B mm	Dim.	Skrue bolt	Stk. pr. pk.
621100301	SB	elforzinket	75	20	2	3,5	10
621100307	KP	elforzinket	75	20	2	3,5	50
621200301	SB	elforzinket	105	20	2	3,5	10
621200307	KP	elforzinket	105	20	2	3,5	25
621300307	KP	elforzinket	130	26	2,5	4,5	25

Flatjárn

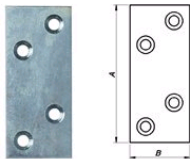

Art. nr.	Pakning	Overflade	A mm	B mm	Dim.	Skrue bolt	Stk. pr. pk.
623000307	KP	elforzinket	86	38	2,5	5	25
623100307	KP	elforzinket	126	38	2,5	5	25
623200307	KP	elforzinket	176	38	2,5	5	25

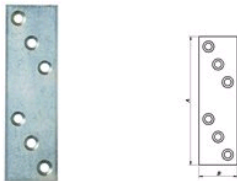
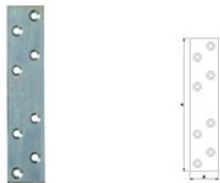

Borðvinkill einfaldur

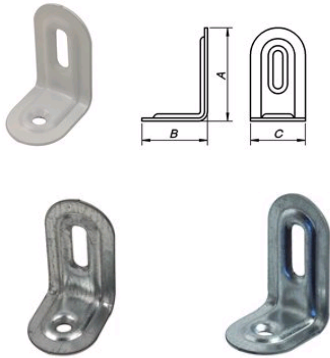

Art. nr.	Pakning	Overflade	A mm	B mm	C mm	Dim.	Skrue bolt	Stk. pr. pk.
630000230	LP	hvid pulverlak	39	28	23	1,25	3,5	100
630000231	SB	hvid pulverlak	39	28	23	1,25	3,5	10
630000237	KP	hvid pulverlak	39	28	23	1,25	3,5	50
630000300	LP	elforzinket	39	28	23	1,25	3,5	100
630000301	SB	elforzinket	39	28	23	1,25	3,5	10
630000303	LP	elforzinket	39	28	23	1,25	3,5	1000
630000307	KP	elforzinket	39	28	23	1,25	3,5	50

Borðvinkill tvöfaldur

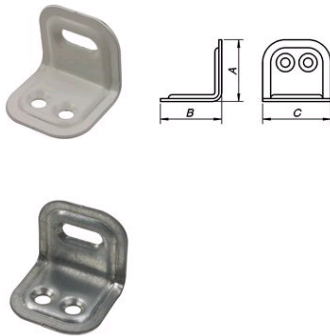

Art. nr.	Pakning	Overflade	A mm	B mm	C mm	Dim.	Skrue bolt	Stk. pr. pk.
631000230	LP	hvid pulverlak	27	27	30	1,25	3,5	100
631000231	SB	hvid pulverlak	27	27	30	1,25	3,5	10
631000237	KP	hvid pulverlak	27	27	30	1,25	3,5	50
631000300	LP	elforzinket	27	27	30	1,25	3,5	100
631000301	SB	elforzinket	27	27	30	1,25	3,5	10
631000303	LP	elforzinket	27	27	30	1,25	3,5	1000
631000307	KP	elforzinket	27	27	30	1,25	3,5	50

Mubluvinkill plast

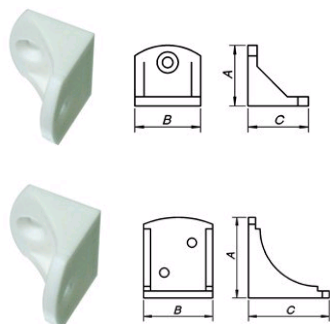

Art. nr.	Pakning	Overflade	A mm	B mm	C mm	Stk. pr. pk.
640009031	SB	hvid plast	23	25	23	10
640009037	LP	hvid plast	23	25	23	100
640109031	SB	hvis plast	35	30	35	10
640109037	LP	hvid plast	35	30	35	100
640209031	SB	hvid plast	52	35	52	10

Armkrækja rafgalv.

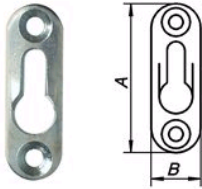

Art. nr.	Pakning	Overflade	A mm	B mm	Dim.	Skrue bolt	Stk. pr. pk.
644000300	LP	elforzinket	42	14	3	3,5	100
644000301	SB	elforzinket	42	14	3	3,5	10

Rúmhakar

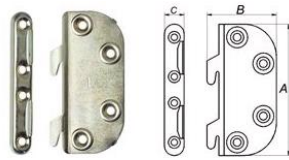

Art. nr.	Pakning	Overflade	A mm	B mm	C mm	Sæt pr. enh.	Sæt pr. pk.
645000361	SB	elforzinket	100	53	15	4	5

Rúmhakar

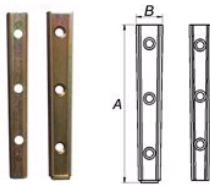

Art. nr.	Pakning	Overflade	A mm	B mm	Skrue bolt	Stk. pr. pk.
645400363	LP	elforzinket	75	18	3,5	300
645500360	LP	elforzinket	105	18	3,5	25

Felliborðafesting

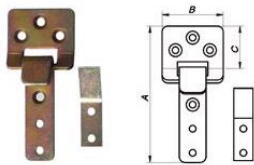

Art. nr.	Pakning	Overflade	A mm	B mm	C mm	Skrue bolt	Sæt pr. enh.	Sæt pr. pk.
646100361	SB	elforzinket	73	32	22	3	2	5

Slá, hvít u/borð (par)

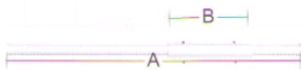

Vörunúmer: **646500431**

Art no.	Pakning	Overflade	A mm	B mm	Dim.	Stk. Pr. Enh.	Stk. pr. pk.
6465-0-04-31	SB	pulverlak. hvid	600	170	22x1,5	2	1

Skilrúmsberar

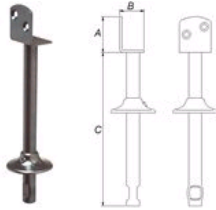

Art. nr.	Pakning	Overflade	A mm	B mm	C mm	Stk. pr. pk.
654000300	LP	elforzinket	36	25	155	10

Skilrúmbæri

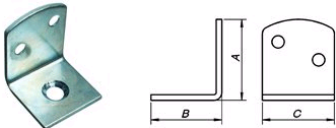

Art. nr.	Pakning	Overflade	A mm	B mm	Dim.	Stk. pr. pk.
656500300	LP	elforzinket	35	25	2,5	10
656600300	LP	elforzinket	36	32	2,5	10
927608909		ryðfrítt	40	32		4

Skilrúmafesting. 4stk m/skrúfum Ryðfrítt

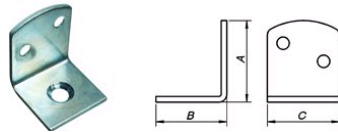

Vörunúmer: 927608909

40x32 L

Skilrúmsmillistykki

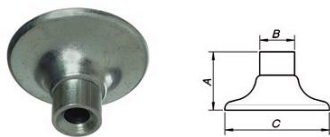

Art. nr.	Pakning	Overflade	A mm	B mm	C mm	Stk. pr. pk.
657009300	LP	elforzinket	25	15	45	10
657209300	LP	elforzinket	80	15	45	10

Skilrúmafesting

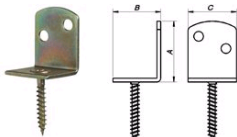

Art. nr.	Pakning	Overflade	A mm	B mm	Dim.	Skrue bolt	Stk. pr. pk.
657600367	KP	elforzinket	40	32	2,5	4	25

Handriðafesting

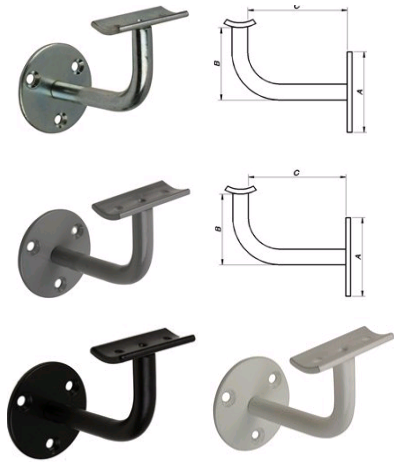

Art. nr.	Pakning	Overflade	A mm	B mm	C mm	Dim.	Skrue bolt	Stk. Pr. Enh.	Stk. pr. pk.
661000301	SB	elforzinket	50	45	63	20x46	4	1	5
661000307	KP	elforzinket	50	45	63	20x46	4		10
661000407	KP	brun pulverlak	50	45	63	20x46	4		10
661000417	KP	grá pulverlak	50	45	63	20x46	4		10
661000427	KP	sort pulverlak	50	45	63	20x46	4		10
661000431	SB	hvid pulverlak	50	45	63	20x46	4	1	5
661000437	KP	hvid pulverlak	50	45	63	20x46	4		10
661008907	KP	rustfrit	50	45	63	20x46	4		5

Kofforthalda

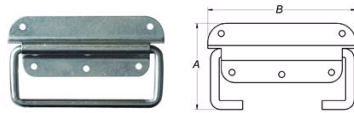

Art. nr.	Pakning	Overflade	A mm	B mm	Dim.	Skrue bolt	Stk. pr. pk.
665000300	LP	elforzinket	64	110	1,5	4,5	10
665000301	SB	elforzinket	64	110	1,5	4,5	5
665000307	KP	elforzinket	64	110	1,5	4,5	5

Kjallarahlerahald rafgalv

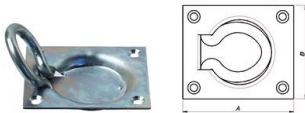

Art. nr.	Pakning	Overflade	A mm	B mm	Dim.	Skrue bolt	Stk. Pr. Enh.	Stk. pr. pk.
667000301	SB	elforzinket	90	75	2	4,5	1	5
667000307	KP	elforzinket	90	75	2	4,5		10

Kjallarahlerahald Messing

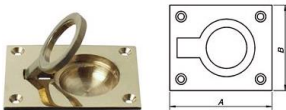

Art. nr.	Pakning	Overflade	A mm	B mm	Dim.	Skrue bolt	Stk. Pr. Enh.	Stk. pr. pk.
668007801	SB	messing	64	52	2	3	1	5

Borðfótur

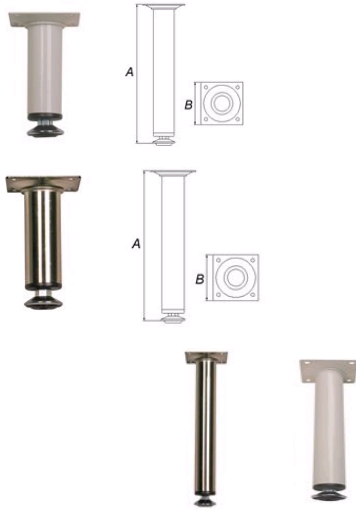

Art. nr.	Pakning	Overflade	A mm	B mm	Stk. pr. pk.
670000437	KP	hvid	100	61	1
670009907	KP	børstet stål	100	61	1
670100437	KP	hvid	200	61	1
670109907	KP	børstet stål	200	61	1
670200437	KP	hvid	300	61	1
670209907	KP	børstet stål	300	61	1
670300437	KP	hvid	400	61	1
670309907	KP	børstet stål	400	61	1
670400437	KP	hvid	500	61	1
670409907	KP	børstet stål	500	61	1
670500437	KP	hvid	600	61	1
670509907	KP	børstet stål	600	61	1
670600437	KP	hvid	700	61	1
670609907	KP	børstet stål	700	61	1
670700437	KP	hvid	800	61	1
670709907	KP	børstet stål	800	61	1
670800437	KP	hvid	900	61	1
670809907	KP	børstet stål	900	61	1

Borðfótur 50x700mm hvítur

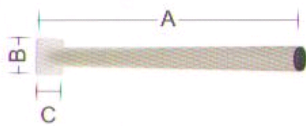

Art no.	Pakning	Overflade	A mm	B mm	C mm	Dim.	Skrue/bolt	Stk. pr. pk.
6720-0-04-37	KP	pulverlak, hvid	700	95	95	50x1,5	5	1

Borðfótur 60x700mm hvítur



Art. nr.	Pakning	Overflade	A mm	Stk. pr. pk.
672100437	KP	hvid	700	1

Borðfótur

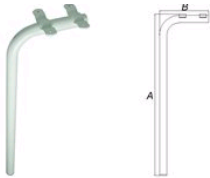

Art. nr.	Pakning	Overflade	A mm	B mm	Dim.	Skrue bolt	Stk. pr. pk.
671000437	KP	hvid pulverlak	700	215	32x1,5	5,5	1
671200437	KP	hvid pulverlak	880	215	32x1,5	5,5	1

Stiliskrúfa f/borðfót 32mm

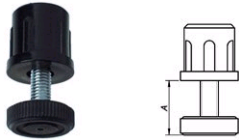

Art. nr.	Pakning	Overflade	A mm	Stk. pr. pk.
671509027	KP	sort	25	10

Hilluvinkill Beyki

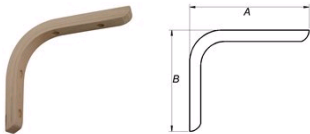

Art. nr.	Pakning	Overflade	A mm	B mm	Stk. pr. pk.
683006407	KP	lamineret bøg	125	150	10
683106407	KP	lamineret bøg	150	175	10
683206407	KP	lamineret bøg	175	200	10
683306407	KP	lamineret bøg	200	250	10

Stiliskrúfa f/borðfót 50mm



Art no.	Pakning	Overflade	A mm	Stk. pr. pk.
6716-0-90-27	KP	spec. sort	28	10

Hilluvinkill Tré

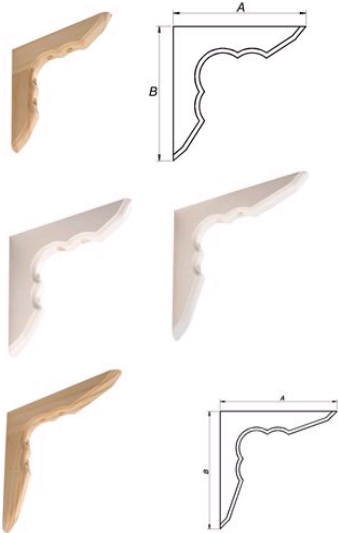

Art. nr.	Pakning	Overflade	A mm	B mm	Stk. pr. pk.
683505407	KP	træ	150	150	10
683505437	KP	hvid	150	150	10
683605407	KP	træ	180	180	10
683605437	KP	hvid	180	180	10
683705407	KP	træ	230	230	10
683705437	KP	hvid	230	230	10
683805407	KP	træ	280	280	10
683805437	KP	hvid	280	280	10

Vegguppistaða fyrir Uglur (Sparring), hvít



Art. no.	Packing	Surface	A mm	Pc. per. pack.
680000417	KP	grey	425	10
680000437	KP	white	425	10
680100417	KP	grey	710	10
680100437	KP	white	710	10
680200417	KP	grey	1000	10
680200437	KP	white	1000	10
680300417	KP	grey	1220	10
680300437	KP	white	1220	10
680400417	KP	grey	1600	10
680400437	KP	white	1600	10
680500417	KP	grey	1980	10
680500437	KP	white	1980	10
680600417	KP	grey	2380	10
680600437	KP	white	2380	10

Ugla tvöföld, Hvít (Sparring)

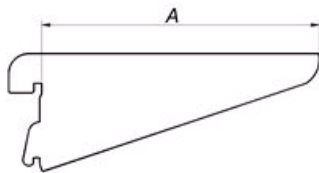

Art. no.	Packing	Surface	A mm	Capacity kg	Pc. per. pack.
681000417	KP	grey	120	130	10
681000437	KP	white	120	130	10
681100417	KP	grey	170	100	10
681100437	KP	white	170	100	10
681200417	KP	grey	220	80	10
681200437	KP	white	220	80	10
681300417	KP	grey	270	70	10
681300437	KP	white	270	70	10
681400417	KP	grey	320		10
681400437	KP	white	320	60	10
681500417	KP	grey	370	45	10
681500437	KP	white	370	45	10

Ugla tvöföld, Hvít (Sparring)

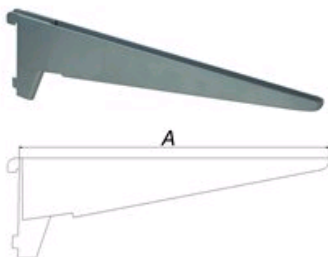

Art. no.	Packing	Surface	A mm	Capacity kg	Pc. per. pack.
682000417	KP	grey	370	85	6
682000437	KP	white	370	85	10
682100417	KP	grey	470	75	6
682100437	KP	white	470	75	10
682200417	KP	grey	610	70	6
682200437	KP	white	610	70	10

Híllu-/Borðvink.Hítir

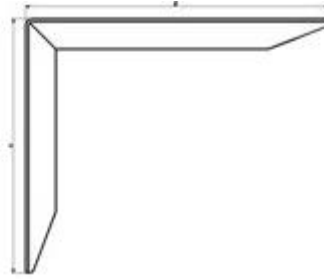

Hægri 25x30: **605510437** Vinstri: 25x30: **605520437**
Hægri 30x40: **605610437** Vinstri: 30x40: **605620437**
Hægri 30x50: **605710437** Vinstri: 30x50: **605720437**

Vinkiljárn 105x20x2,5 Rafg



611500307

Flatjárn GZ 130x25x2,5 2stk

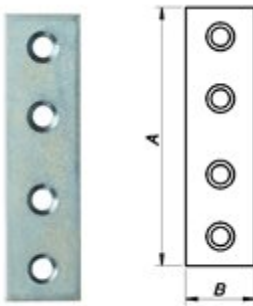

621300301

Vinkiljárn 4st.GZ m/skrúfum

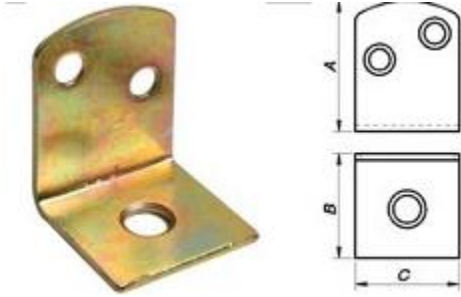

927500309